



Capri Marquee

Capri Marquees are unusual, tensioned structures which eliminate the need for guy ropes, making our marquees eye-catching and strikingly different than the standard marquee.

One of our many features is that we can tailor-make the marquees to the size you require simply by linking two or more tents together, increasing the capacity to suit your individual needs. They can accommodate between 35 - 300 people standing and 25 - 240 seated.

Capri Marquees are versatile and are ideal for any event such as:
weddings, birthdays, cocktail parties, fetes, product launches and corporate functions to name a few. They are also totally weather proof as they have detachable walls in a choice of either clear or white.

The Capri marquee is 16 foot high at the centre poles.

The arches of the marquee are approximately 7ft to 8ft high so plenty of head space, the arches creating a more open feel.

You are able to attach the sides later in the day they should take no longer that a couple of minutes for each side wall. It is a very easy task.









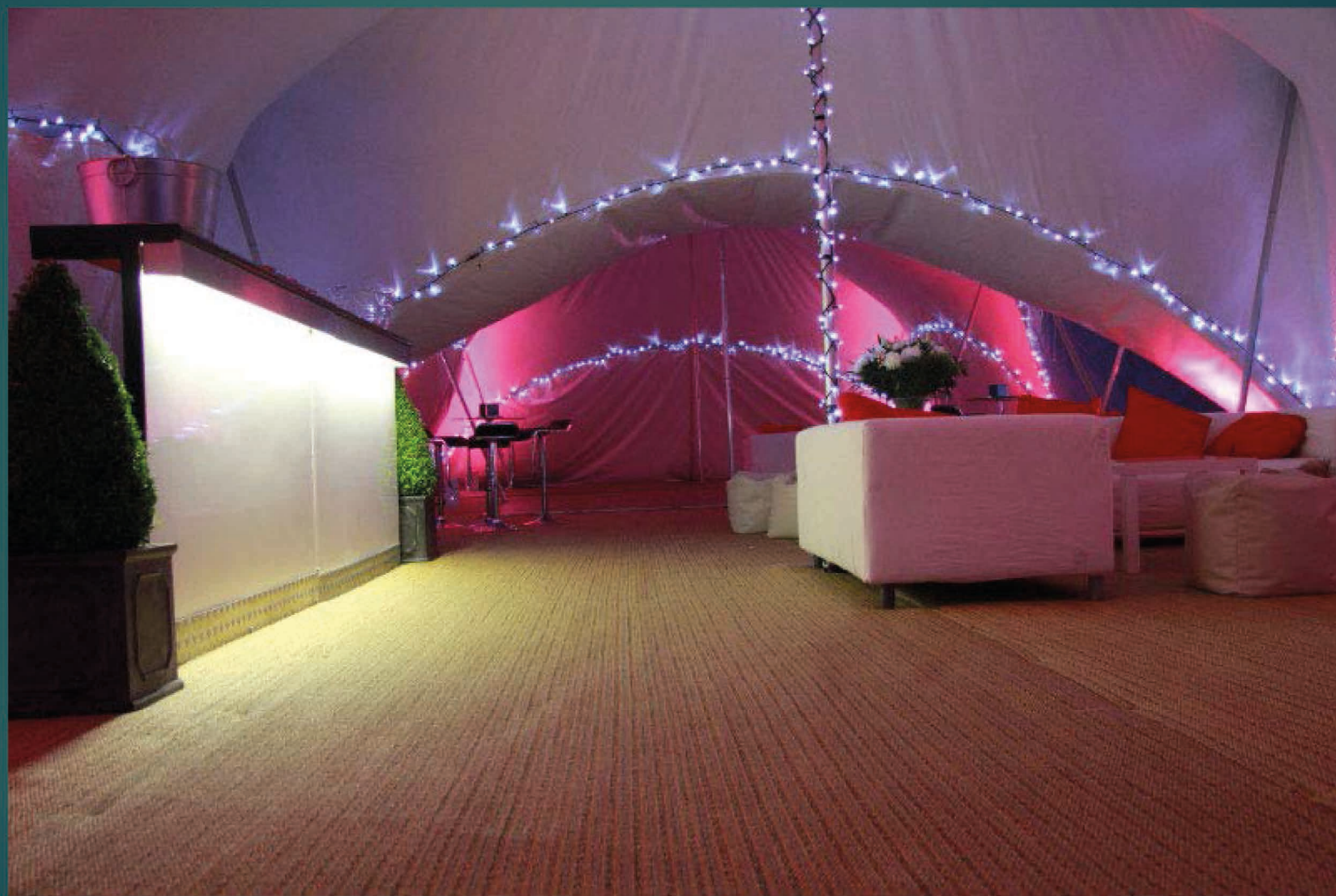





Tent Configurations

We offer a range of different configurations to suit almost every occasions.

Have you got a question?
Don't hesitate to ask!

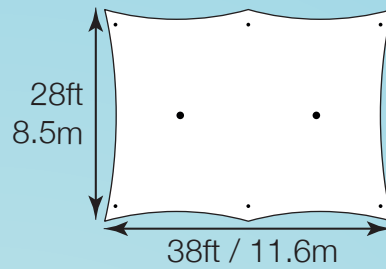

A
Seated: 80
Standing: 100

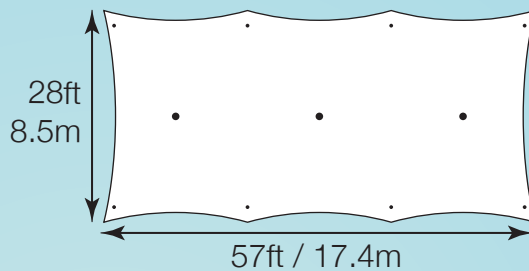

B
Seated: 128
Standing: 160

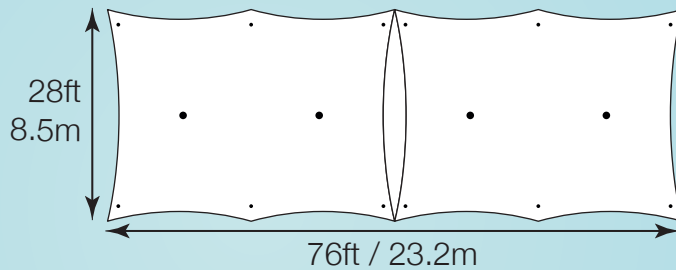
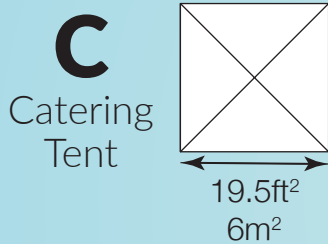

AA
Seated: 176
Standing: 220

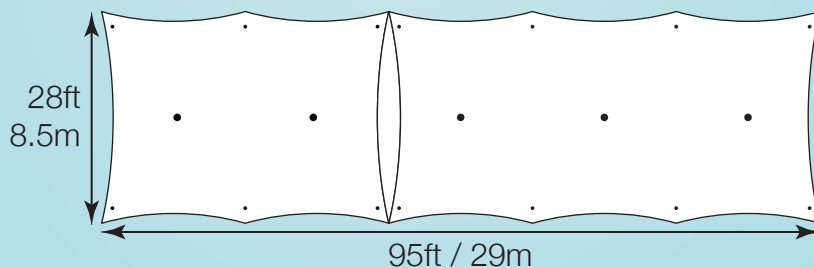

AB
Seated: 224
Standing: 300

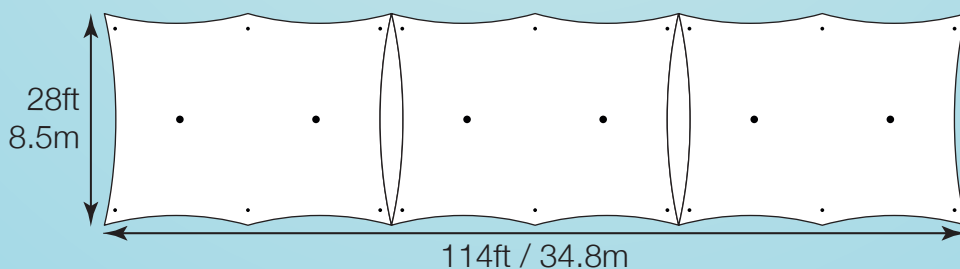

AAA
Seated: 264
Standing: 340

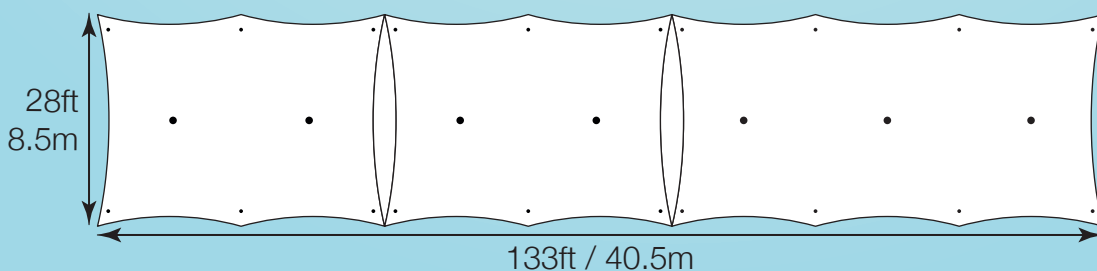

AAB
Seated: 324
Standing: 400

Dimensions

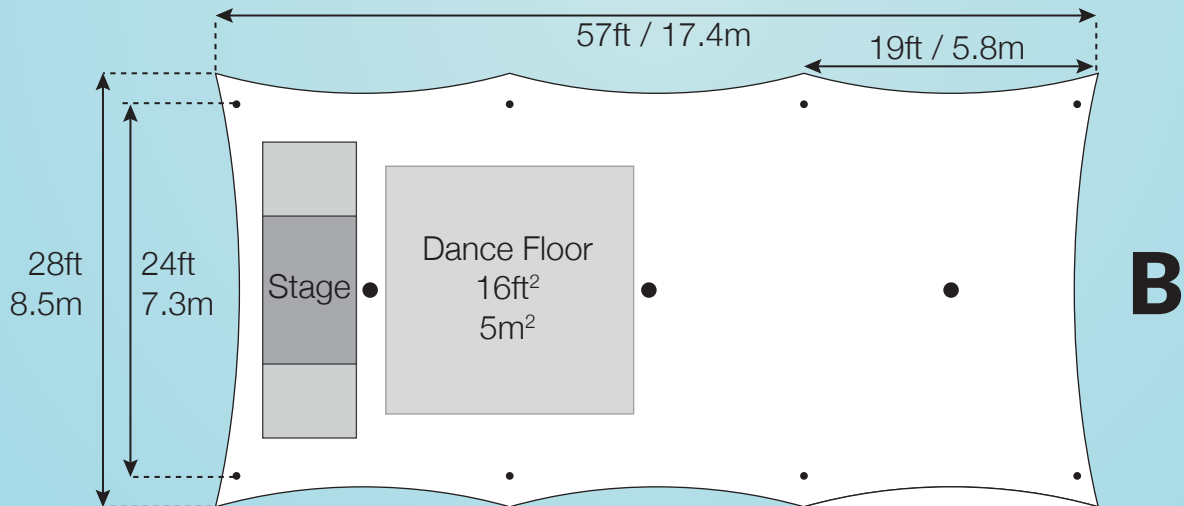
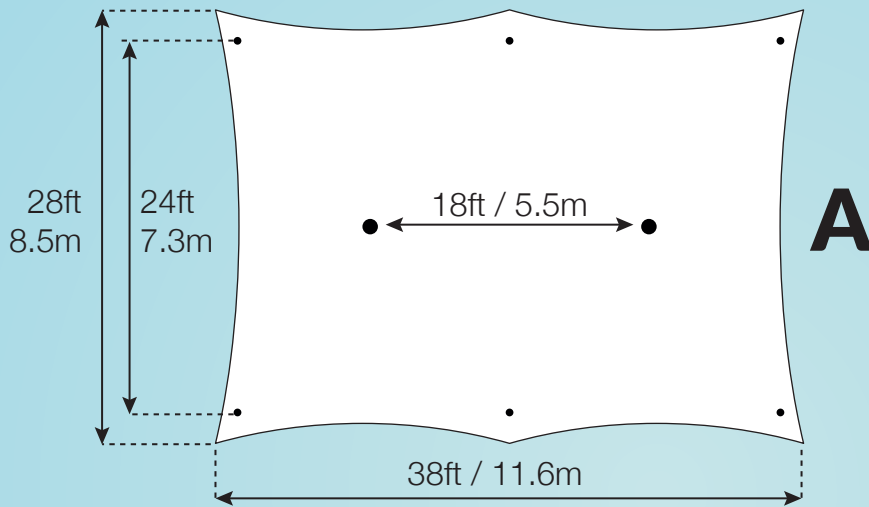
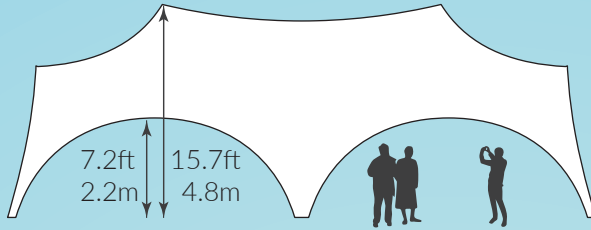

- Small Stage**
- 3 piece band or DJ setup
- 5.9 x 9.8ft / 1.8 x 3m
- Large Stage**
- 5 piece band & large DJ setup
- 5.9 x 19.7ft / 1.8 x 6m

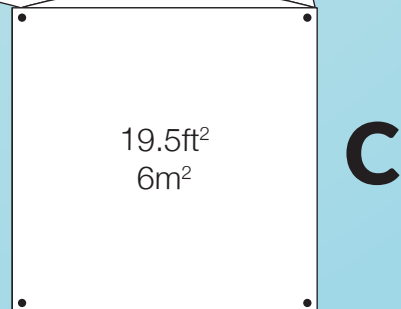

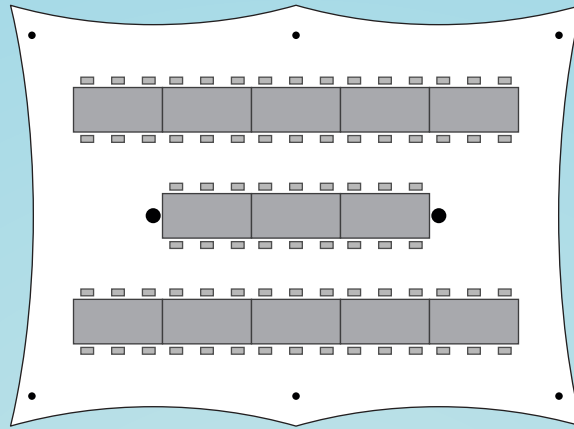

Rectangular Tables

Tables: 13 Seats: 78 Size: 6ft x 3ft / 1.8m x 0.90m

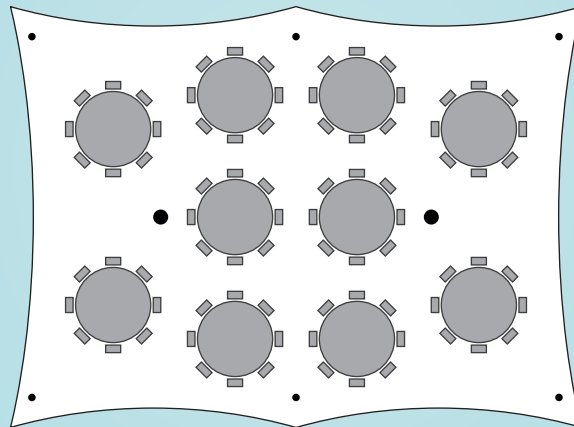

Round Tables

Tables: 10 Seats: 80 Size: 5ft / 1.5m

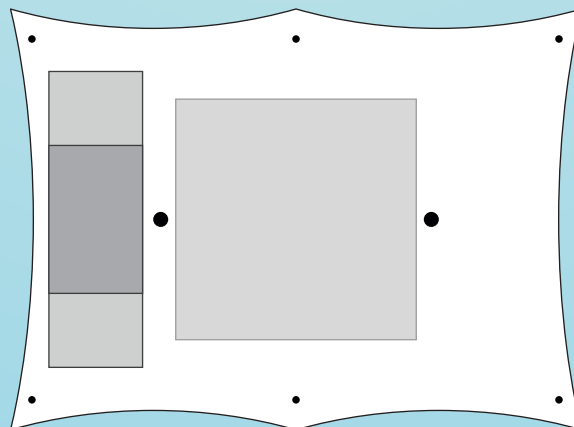

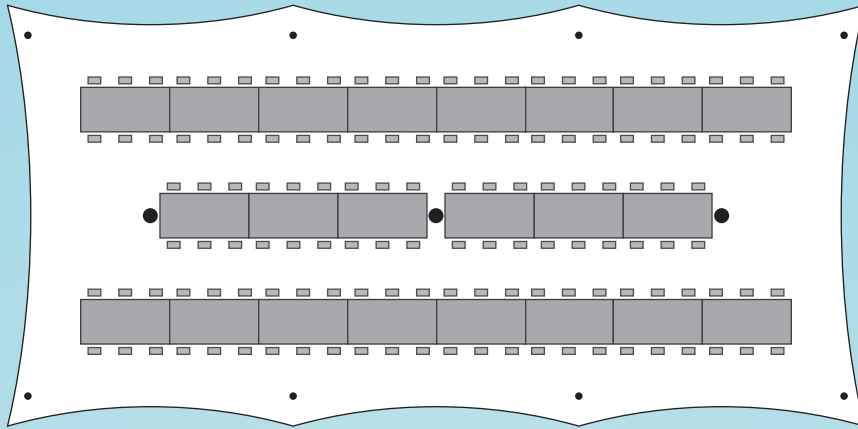

Rectangular Tables

Tables: 22 Seats: 132 Size: 6ft x 3ft / 1.8m x 0.90m

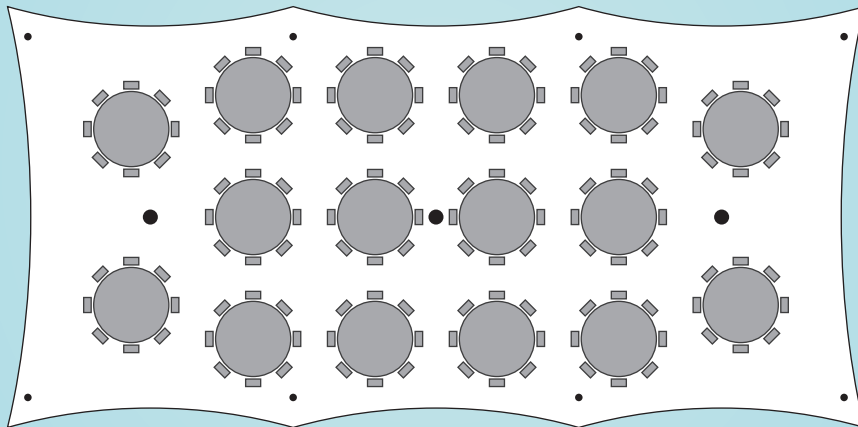

Round Tables

Tables: 16 Seats: 128 Size: 5ft / 1.5m

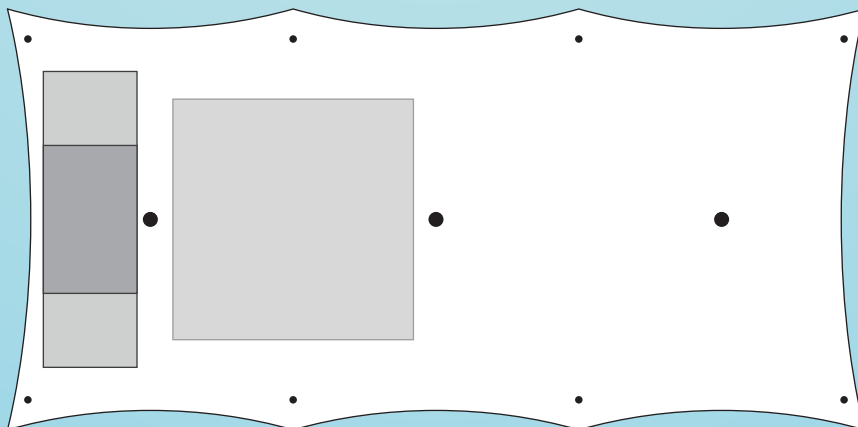

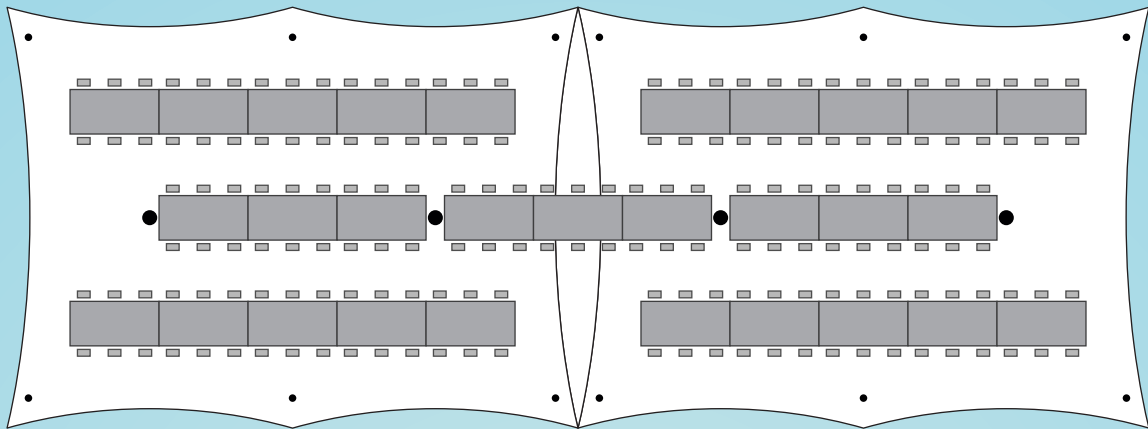

Rectangular Tables

Tables: 29 Seats: 174 Size: 6ft x 3ft / 1.8m x 0.90m

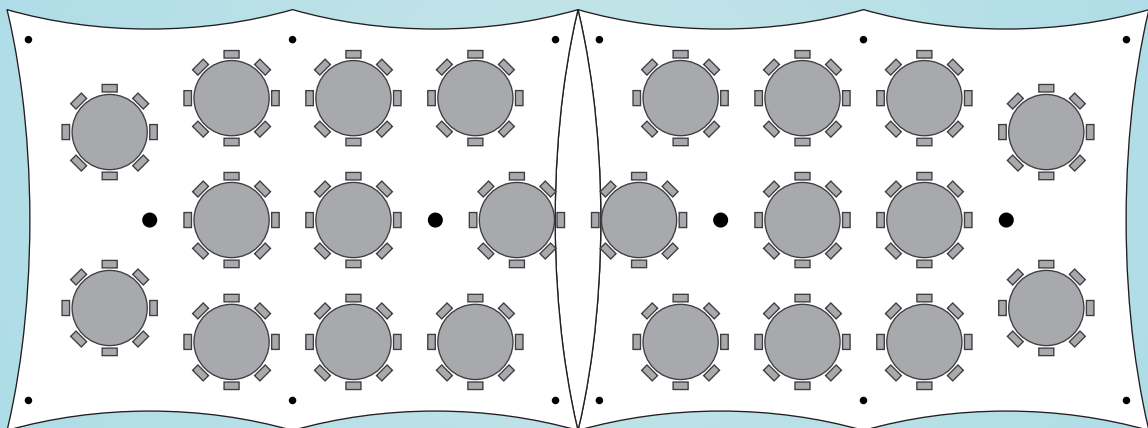

Round Tables

Tables: 22 Seats: 176 Size: 5ft / 1.5m

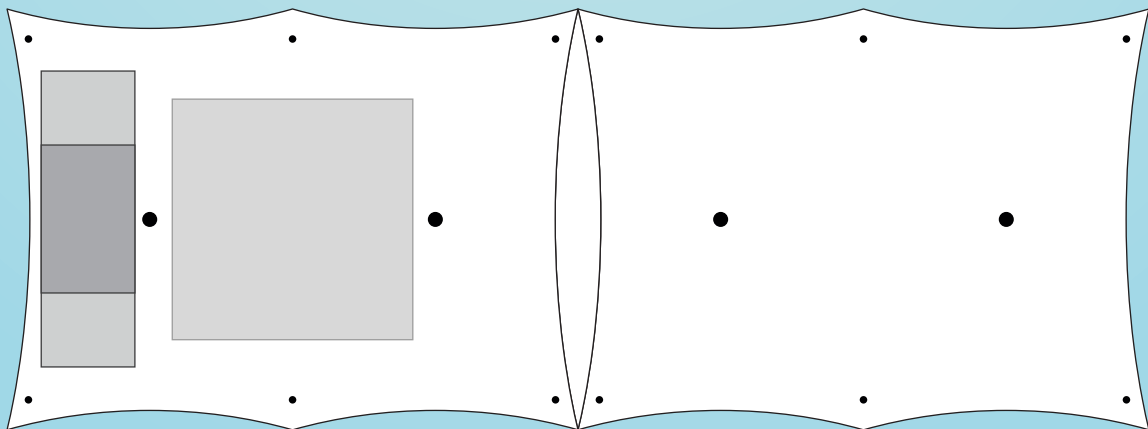

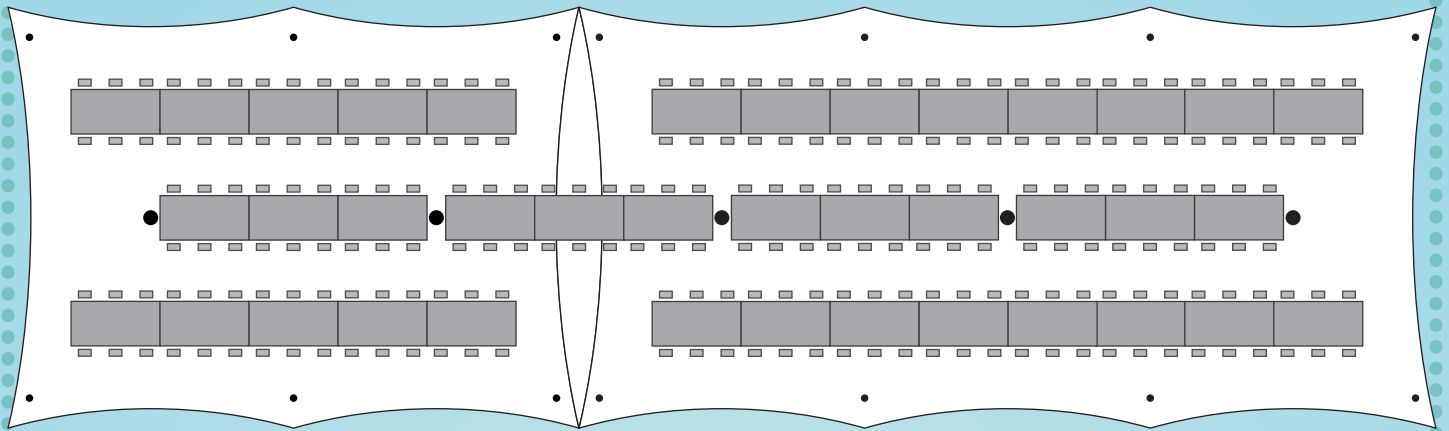

Rectangular Tables

Tables: 38 Seats: 228 Size: 6ft x 3ft / 1.8m x 0.90m

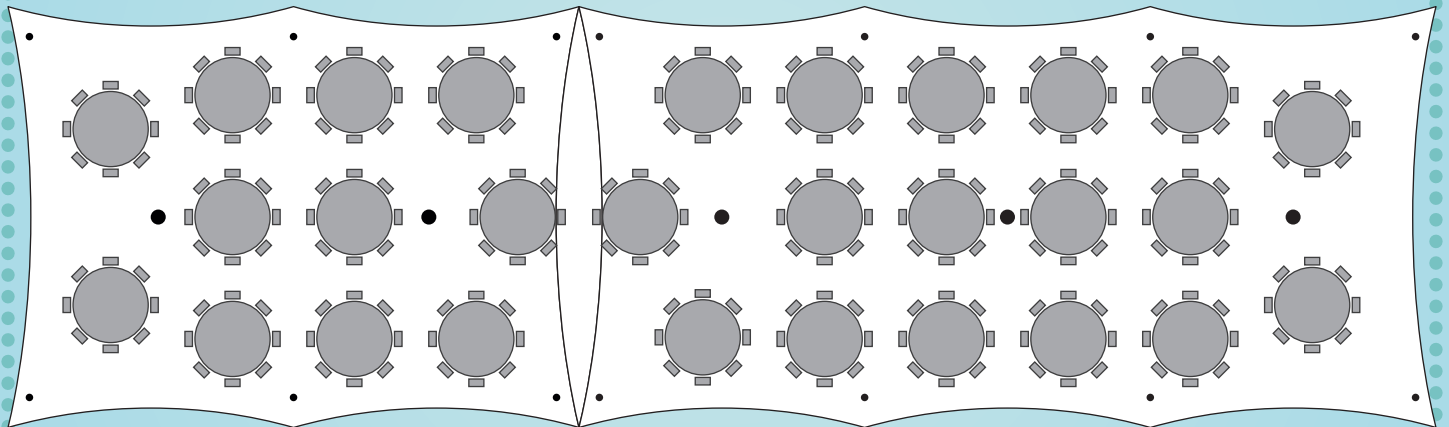

Round Tables

Tables: 28 Seats: 224 Size: 5ft / 1.5m

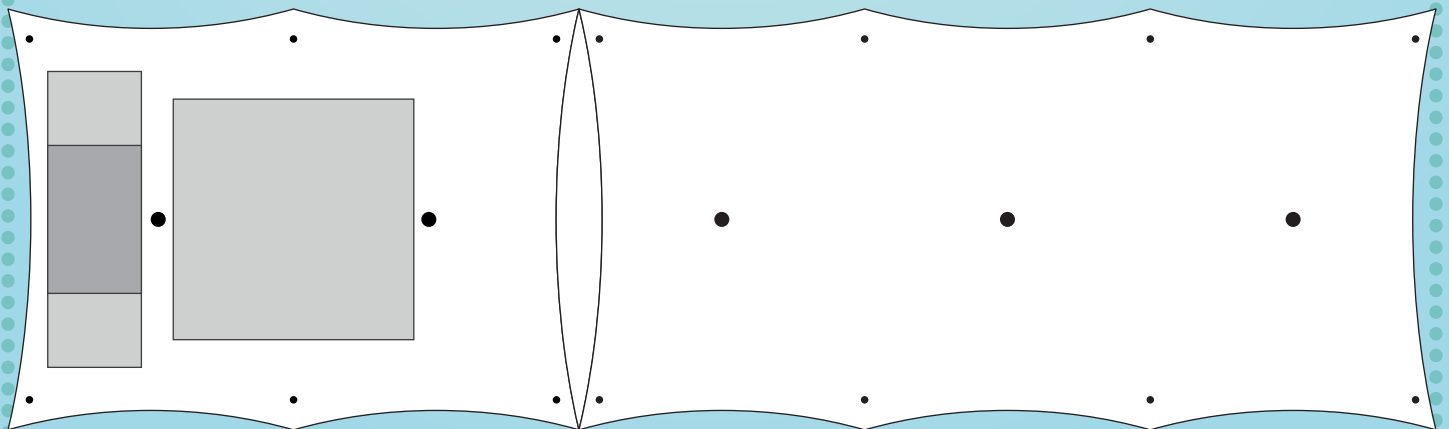

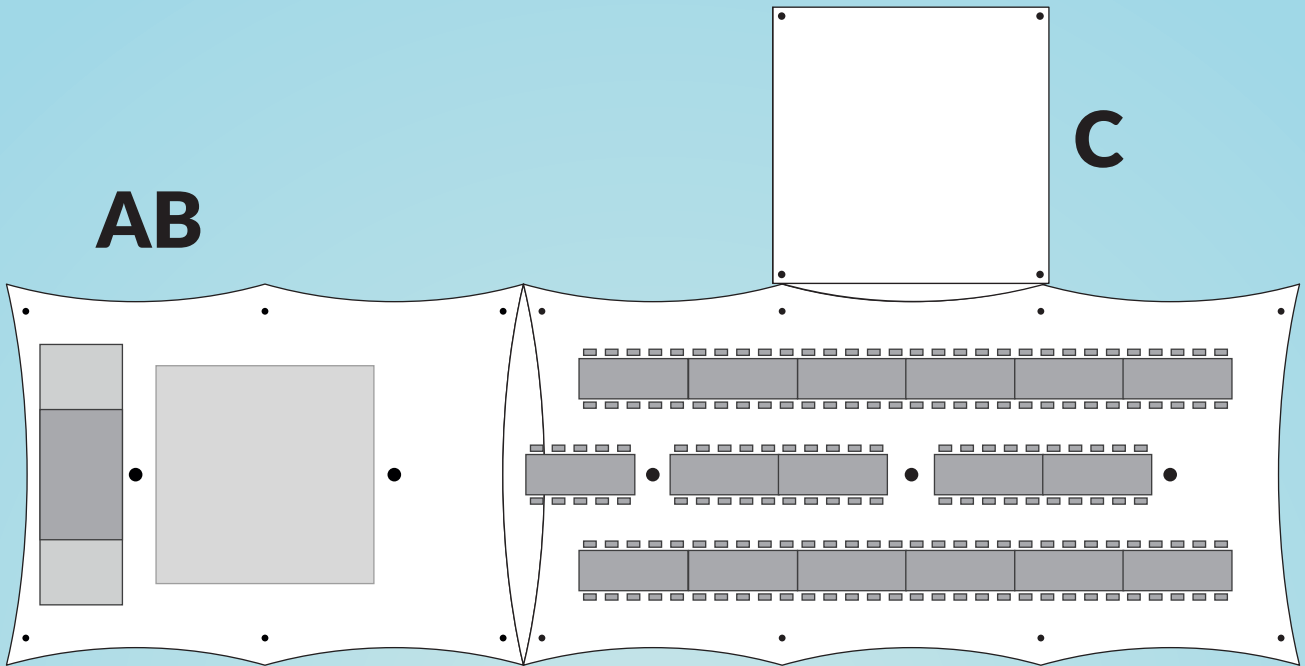

Banquet Tables

Tables: 15 Seats: 150 Size: 8ft x 3ft / 2.4m x 0.90m

